



WINDOW TECHNOLOGY
DOOR TECHNOLOGY
AUTOMATIC ENTRANCE SYSTEMS
BUILDING MANAGEMENT SYSTEMS



DOOR TECHNOLOGY

Door closers with slide rail The OTS 73x series

Securing technology for you



Securing technology for you

Convenience and design – As simple as that.....	4
A system for all applications? It works!.....	8
Perfect function is simply a question of adjustment	12
OTS 73x surface-mounted overhead door closers	18
OTS 73x FL face-fixed overhead door closers with free-swing function	20
Accessories – Surface-mounted overhead door closers.....	22
VTS 735 concealed door closers.....	24
Accessories – Concealed door closers.....	28
All solutions at a glance	30
Hold-open systems.....	32
Successfully certified.....	36
Systematic service	37

Supplement: Overview of modular components

Copyright notice

© All illustrations and texts in this publication are protected by copyright. Unless otherwise stated in the image credits, the rights belong to the Gretsch-Unitas Group. Any use of copyright protected materials without the consent of the holder of the rights is prohibited.

Image credits

Page 4/5 Image of person: Little girl running provided by Getty Images

Publisher

Gretsch-Unitas GmbH | Baubeschläge
Johann-Maus-Str. 3 | D-71254 Ditzingen

Tel. + 49 (0) 71 56 3 01-0 | Fax + 49 (0) 71 56 3 01-2 93

www.g-u.com

Attractive design and very convenient access, installation flexibility and standard-compliant safety: door closers are only truly efficient if they meet all requirements. You can rely on the Gretsch-Unitas Group for this: as one of the international market leaders for window and door technology and automatic entry and building management systems, we are the competent partner for intelligent door closer solutions – from the individual product to an individually coordinated system. The foundation for this is the 100 year old tradition of our family-owned company, which has stood for innovation, progress and cost-effectiveness from the start. With the OTS 73x series, we thus offer a technically advanced solution that pays off from planning to installation through to daily operation. In order to live up to the expectations of our principle "Securing technology for you" we aim to combine first-rate products with first-rate services.

Convenience and design – as simple as that.

Whether for fire protection, barrier-free construction or burglar protection: the use of overhead door closers to automatically close doors plays an important role in public and private buildings. It is therefore extremely fortunate that an exceptionally compact solution that ensures a high degree of comfort and barrier freedom is available! As the smallest of their type, the OTS 73x series of door closers with slide rail combines attractive design with straightforward opening – in compliance with the standards DIN SPEC 1104 and DIN 18040 for barrier-free construction.





Compact and elegant design



A high level of convenience meets slim lines: the OTS 73x series

The comprehensive product range of the OTS 73x series sets standards due to an attractive design and high degree of opening comfort: with more compact dimensions and elegant aesthetics, this generation of tried-and-tested closers with slide arm is still also easy and pleasant to operate.

The bodies of the series OTS 73x are only 63 mm high, 44 mm deep and 268 mm long and are therefore the smallest currently available on the market. All product types have uniform dimensions, hole patterns and looks which ensures that when different door closers are used, the resulting overall appearance is harmonious. The only exception is the free-swing variant where the dimensions vary slightly.

The visually appealing cohesive surface of the OTS 73x series also leaves nothing to be desired: this is ensured by the elegant slide rail cover and the robust cover which is used instead of a slide-on cover. The covers and the slide arm are available in different materials and finishes and can thus be selected to fit the door and the surrounding architecture. The concealed mounting plate adds the final finishing touch to the attractive design.

The OTS 73x series also includes the concealed door closer VTS 735 which meets exceptionally high design and functional demands: mounted in the door leaf, the closer and slide rail remain hidden when the door is closed.

The promise of quality made by the door closer's appearance is kept with clever technology: integrated double-heart curve technology and the optional free-swing function ensure very convenient access.

Advantages at a glance

- Comparatively the smallest closer body on the market: in an elegant, slim design
- Robust cover instead of a slider: available in different materials and finishes
- Concealed mounting plate: for a high-quality cohesive visual appearance
- The dimensions are practically uniform throughout the entire range of door closers: this has a harmonious effect on the overall project
- Uniform drilling pattern for all door closer types



A system for all applications? It works!

The possible applications for overhead door closers are as diverse as the functions of the doors themselves. The OTS 73x series covers all applications with its innovative modular system: the components are simply combined to meet requirements and adjusted individually. This not only makes planning, installation and retrofitting easier: it also saves storage space and fixing accessories.





The innovative modular system of the OTS 73x series



The right solution for any application

School, hotel or airport? Single or double-leaf door? Installation on the hinge-side or the side opposite to hinges? Transom or standard installation? Each door closer is an individual answer to specific building situations and door variants. The innovative modular system of the OTS 73x series meets these requirements in every respect which makes it much easier to plan and install any application.

The possible uses range from simple door closing to fire protection all the way through to barrier freedom. In addition, the modular system allows fast retrofitting and easy incorporation of additional functions when implementing special solutions.

The OTS 73x series makes all this happen as it contains suitable components for all applications and mounting variants across the board: the slide rail and slide arm, the symmetrical mounting plate and axle extension are always the same. Without being dismantled, they can be flexibly expanded with additional components – for example, with a mechanical or electro-mechanical hold-open device, door leaf coordinator, opening restrictor and smoke switch module.

The advantage is obvious: those who have components that are exactly matched for all requirements need fewer different components in storage and fewer fixing accessories – for more efficiency and cost-effectiveness.

Advantages at a glance

- One slide rail, one slide arm and one axle extension for all application and installation types
- Uniform mounting plate to EN 1154 for all application and installation types
- Uniform installation drilling pattern for all variants prevents confusion
- Fixing pins on the mounting plate for secure, fast installation and steady fixing
- All types of hold-open devices (mechanical and electromechanical) can be opened beyond the hold-open angle

Choose the right solution for you from our modular system

1-leaf solutions

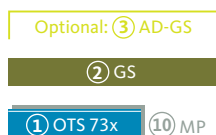

Standard



With mechanical hold-open device

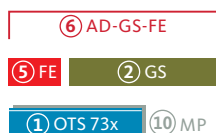

With electromechanical hold-open device

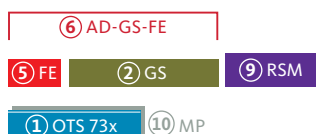

With electromechanical hold-open device and smoke switch module

Double-leaf solutions with SRI door leaf coordinator



Standard



With mechanical hold-open device



With electromechanical hold-open device

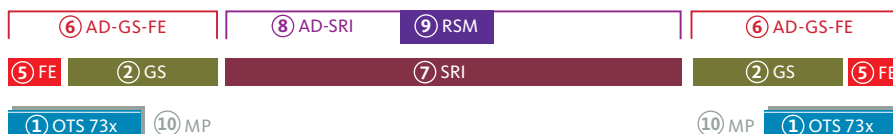

With electromechanical hold-open device and smoke switch module

One slide rail for all applications



1-leaf – OTS 73x



2-leaf – OTS 73x SRI



Standard installation
on hinge-side



Standard installation
on side opposite to hinges



Transom installation
on hinge-side



Transom installation
on side opposite to hinges

The modular system

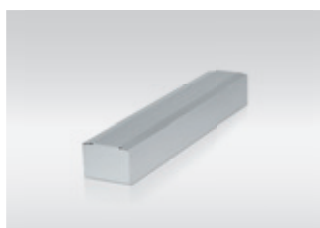

1 OTS 73x / OTS 73x BG door closer

1A Cover



1BS OTS 73x closer body

1BG OTS 73x BG closer body



2 GS slide rail
(with slide arm)



3 AD-GS slide rail cover



4 FM mechanical hold-open device
with ÖB opening restrictor



5 FE electromechanical
hold-open device



6 AD-GS-FE cover for electro-
mechanical hold-open device

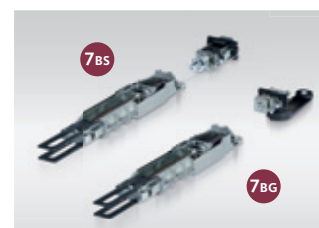

7 SRI door leaf coordinator

7BS SRI 7BG SRI-BG

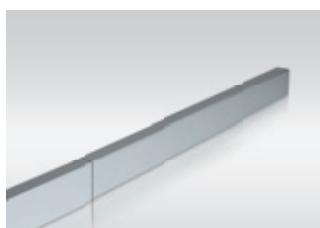

8 AD-SRI cover
for door leaf coordinator



9 RSM smoke switch module



10 MP mounting plate



11 ÖB opening restrictor

BS = Hinge side / BG = Site opposite to hinges

Perfect function is simply a question of adjustment.

How can you tell whether or not a door is working perfectly? When one barely perceives it while walking through. The OTS 73x series ensures this with innovative double-heart curve technology – and sets standards for easily controlled opening and closing movement. Thanks to steplessly adjustable control valves and adjustment of the closing force, the convenience and function of the overhead door closer can be easily adjusted. The entire closing force range (min. EN to max. EN) can be controlled quite simply via nine turns, for example.

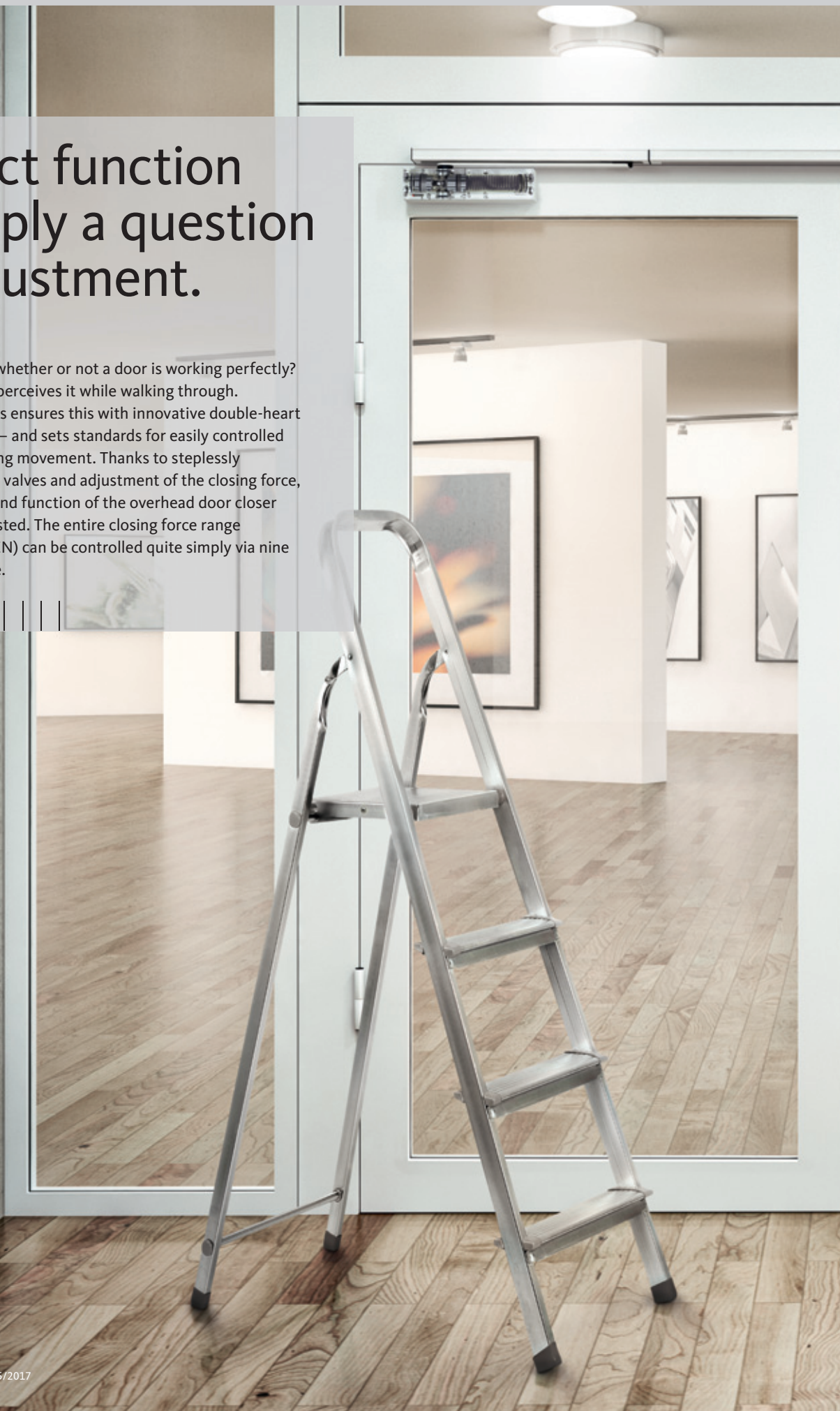



Patent-pending technology meets simple control



Barrier-free convenience due to intelligent use of force

The patented double-heart curve technology of the OTS 73x series allows the door to be opened very easily and comfortably. This enables it to fulfil the DIN SPEC 1104 (CEN/TR 15894) requirements, which prescribe reduction of the opening force by 40% at an opening angle of 2° to 60°. This allows children and elderly persons or persons with physical disabilities to effortlessly pass through large doors.

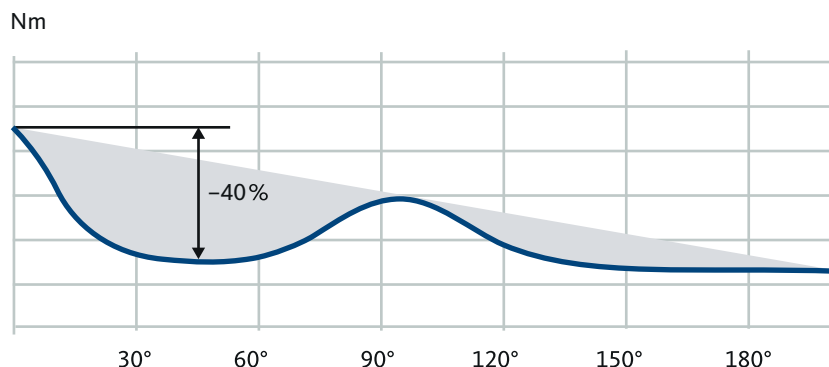

The strongly decreasing force at a door opening angle of 2° to 60° makes opening easier

For controlled opening and closing

The closing movement can be controlled and regulated individually in all product variants of the OTS 73x series: this is ensured by the precise closing force display and convenient closing force adjustment,

among other things. With the colour-coded, robust control valves made entirely of metal, closing speed, latching speed and backcheck can also be individually adjusted to the building situation and the needs of users.

Advantages at a glance

- Patented double-heart curve technology for maximum comfort
- Opening and closing movement can be precisely controlled
- Colour-coded control valves prevent confusion during adjustment



- 1 Closing force adjustment
- 2 Closing force display

For convenient closing force adjustment with only nine turns (EN min. up to EN max.) and visible display of the adjusted closing force.



- 3 Double-heart curve technology

Ensures optimum function of the closing shaft for smooth opening.



- Control valves
- 4 Closing speed
- 5 Latching speed
- 6 Backcheck

Steplessly adjustable and colour-coded – for convenient and confusion-free adjustment.

All expectations incorporated.

Whether face-fixed, with free-swing function or concealed: with an all-encompassing product range the slide rail door closer generation of the OTS 73x series caters for an extremely wide range of applications and requirements. Irrespective of which door closer version you use, rest assured it will always provide security that complies with the standards.



OTS 73x FL overhead door closers with free-swing function

OTS 73x overhead door closers



VTS 735 concealed door closers



OTS 73x surface-mounted overhead door closers



Thanks to simple installation and high functional safety, surface-mounted OTS overhead door closers can be installed on the hinge-side or the side opposite to hinges. Can also be used on double-leaf doors. A concealed door leaf coordinator which is integrated into the slide rail ensures the correct closing sequence of active and passive leaf.

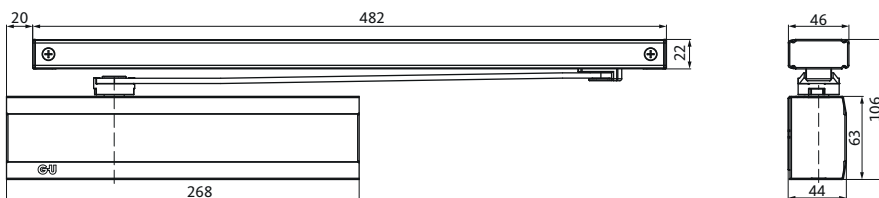

Overview of variants

Type designation	OTS 735	OTS 735 BG	OTS 736	OTS 736 BG	OTS 736 SV	OTS 736 SV BG
Installation	Hinge-side	Side opposite to hinges	Hinge-side	Side opposite to hinges	Hinge-side	Side opposite to hinges
Closing force size according to EN 1154	2-5	2-5	3-6	3-6	3-6	3-6

Product features

Door closers

- Tested in accordance with EN 1154
- With double-heart curve technology. This ensures DIN SPEC 1104 conformity and suitability for barrier-free construction according to DIN 18040
- Smallest dimensions (L x H x D): 268 x 63 x 44 mm for all variants, including cover
- Valve functions
 - Closing speed
 - Latching speed
 - Backcheck
- With closing force display
- Simple and safe adjustment of closing force with just a few turns of the adjustment screw (max. 9 turns EN min. up to EN max.)
- Cover in an attractive design – available in different materials and finishes
- Cover with safeguard
- Colour-coded control valves prevent confusion during adjustment
- Plastic valves ensure that the closing function continues to work in the event of temperature fluctuations
- Security valves in the closer protects against overload operation
- Optional with delayed closing action (Type OTS 736 SV)^[1]

Slide rail

- One slide rail for all application and installation types (modular system)
 - For hinge-side and side opposite to hinges
 - For standard and transom installation
- Slide rail installation height
 - Standard (without cover): 22 mm
 - Standard (with cover): 25 mm
- With integrated cable channel for electromechanical hold-open device (FE)
- Fast and uncomplicated extension with further components:
 - FM mechanical hold-open device^[1]
 - FE electromechanical hold-open device
 - SRI door leaf coordinator
 - ÖB opening restrictor

Application ranges

- Fire and smoke protection doors
- For swing doors up to 1400 mm (1-leaf) or 2800 mm (2-leaf)
- DIN left and DIN right
- Hinge side and side opposite to hinges
- Standard and transom installation
- Max. door opening and closing angle
 - Standard installation on hinge-side: 180°
 - Standard installation on side opposite to hinges: 120°^[2]
- Greater range of application with installation on side opposite to hinges, e.g. opening angle of approx. 113° with an X-dimension of 100
- Min. door leaf width: 600 mm

[1] Not approved for fire and smoke protection doors.

[2] Depending on installation situation. Use door stop for max. door opening angle.

OTS 73x FL face-fixed overhead door closers with free-swing function



The surface-mounted OTS 735 FL and OTS 736 FL overhead door closers enable the user to easily access a fire protection door. The integrated electrical free-swing function, which can be activated from 0°, allows the door freedom of movement, as if no door closer were installed. Safe and reliable door locking is still ensured in the event of a fire. This makes them particularly suitable for use on fire protection doors in nursery schools, schools and retirement homes – standard-compliant for barrier-free construction in accordance with DIN 18040 and DIN SPEC 1104.

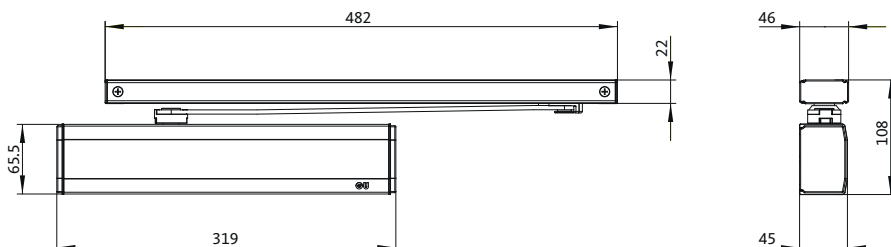

Overview of variants

Type designation	OTS 735 FL	OTS 735 FL BG	OTS 736 FL	OTS 736 FL BG
Installation	Hinge-side	Side opposite to hinges	Hinge-side	Side opposite to hinges
Closing force size according to EN 1154	5	5	6	6

Product features

Door closers

- Tested in accordance with EN 1154
- Tested in accordance with EN 1155
- Tested and approved by DIBt (German Institute of Building Engineering)
- With electrically integrated free-swing function, can be activated from 0°–140°
- Accessibility of a door up to 1400 mm (1-leaf), without exertion of force in both directions, as if no door closer were installed
- Secure and automatic closing in the event of a fire, making it ideal for installation on 1- and 2-leaf fire and smoke protection doors
- Smallest dimensions (L x H x D): 319 x 65.5 x 45 mm, including cover
- Valve functions
 - Closing speed
 - Latch action
- No special components: all components of the modular system in the OTS 73x series can be used
- Uniform drilling-hole pattern with all door closers of the OTS 73x series

Slide rail

- Slide rail of the OTS 73x series for all application and installation types (modular system)
 - For hinge-side and side opposite to hinges
 - For standard and transom installation
- Slide rail installation height
 - Standard (without cover): 22 mm
 - Standard (with cover): 25 mm
- Fast and uncomplicated extension with further components:
 - SRI door leaf coordinator
 - ÖB opening restrictor

Application ranges

- Fire and smoke protection doors
- For swing doors up to 1400 mm (1-leaf) or 2800 mm (2-leaf)
- DIN left and DIN right
- Hinge side and side opposite to hinges
- Standard and transom installation
- Max. door opening and closing angle
 - Standard installation on hinge-side: 180°
 - Standard installation on side opposite to hinges: 120° ^[1]
- Min. door leaf width: 600 mm

[1] Depending on installation situation.
Use door stop for max. door opening angle.



FM mechanical hold-open device ^[1] with OB opening restrictor

- Can be integrated in the slide rail
- Steplessly adjustable from 80°–140°
- With integrated opening restriction
- On-/Off-switchable override function
- Retrofittable



FE electromechanical hold-open device

- Can be extended laterally on the slide rail
- Tested and certified in accordance with EN 1155
- Tested and approved by DIBt (German Institute of Building Engineering)
- Steplessly adjustable hold-open angle from 85°–140°
- Two different hold-open ranges can be preset at the same time
- Retrofittable, without additional drill hole
- Complete opening beyond hold-open angle possible up to 180°
- The hold-open device can also be triggered manually at any time



SRI door leaf coordinator

- Can be integrated in the slide rail
- Tested and certified in accordance with EN 1158
- SRI waiting position with load-limiting device prevents damages in case of mishandling
- Optional: with integrated microswitch for conjunction with the FE electromechanical hold-open device. If the active leaf is manually operated, the passive leaf is also automatically closed
- Retrofittable

[1] Not approved for fire and smoke protection doors.

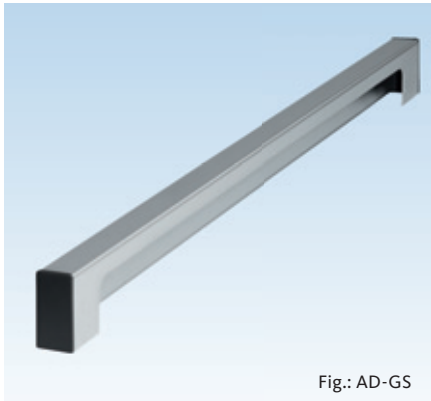

Fig.: AD-GS

AD covers

AD-GS slide rail cover

AD-GS-FE cover for electromechanical hold-open device

AD-SRI cover for door leaf coordinator

- For the highest expectations in terms of appearance and design
- Available in all colours also in stainless steel
- Simple and fast installation
- Installation height: 25 mm



MP mounting plate

- Symmetrical
- For all door closer types and mounting variants
- With fixing pins for fast secure installation and stable fixing, and also avoiding incorrect installation
- Concealed below the cover



ÖB opening restrictor

- Can be integrated in the slide rail
- Steplessly adjustable limiting angle up to 180°
- Retrofittable

The innovative modular system of the OTS 73x series

Concealed door closers



Choose the right solution for you from our modular system

1-leaf solutions

GS VTS 73x 20x12

VTS 73x

Standard
with standard slide rail

ÖB FM GS VTS 73x 20x12

VTS 73x

With mechanical hold-open device
with standard slide rail

FE GS VTS 73x 26x32

VTS 73x

With electromechanical hold-open device
with functional slide rail

FE GS VTS 73x 26x32 RSM

VTS 73x

With electromechanical hold-open device and smoke switch module
with functional slide rail

Double-leaf solutions with SRI-VTS door leaf coordinator

GS VTS 73x 26x32 SRI-VTS GS VTS 73x 26x32

VTS 73x VTS 73x

Standard
with functional slide rail

ÖB FM GS VTS 73x 26x32 SRI-VTS GS VTS 73x 26x32 FM ÖB

VTS 73x VTS 73x

With mechanical hold-open device
with functional slide rail

FE GS VTS 73x 26x32 SRI-VTS GS VTS 73x 26x32 FE

VTS 73x VTS 73x

With electromechanical hold-open device
with functional slide rail

RSM

FE GS VTS 73x 26x32 SRI-VTS GS VTS 73x 26x32 FE

VTS 73x VTS 73x

With electromechanical hold-open device and smoke switch module
with functional slide rail

Modular components

Closer body



VTS 735 door closer



VTS 735/4 door closer



VTS 735 FL door closer

Standard slide rail 20x12 and accessories



GS VTS 73x 20x12
standard slide rail



FM-VTS 73x 20x12
mechanical hold-open device



ÖB-VTS 73x 20x12
opening restrictor

Functional slide rail 26x32 and accessories



GS VTS 73x 26x32
functional slide rail



FM-VTS 73x 26x32
mechanical hold-open device



FE-VTS 73x26x32
electromechanical hold-open device



SRI-VTS 73x26x32
door leaf coordinator



ÖB-VTS 73x26x32
opening restrictor



RSM smoke switch module

VTS 735 concealed door closers

EN 3-5 for door leaf widths up to 1250 mm



The VTS 735 concealed door closers for single- and double-leaf doors are installed concealed in the door leaf and door frame. Closer and slide rail are not visible when the door is closed. VTS thus meets the highest expectations in terms of function and design.

Door closer variants

- VTS 735 standard
- VTS 735/4 with 4 mm longer axle for use with fire protection cover

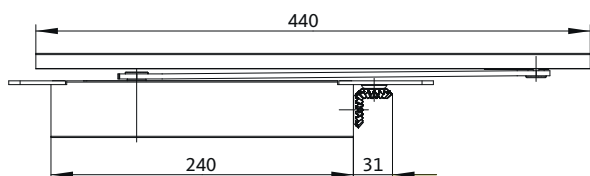

VTS 735 concealed door closer – with standard slide rail

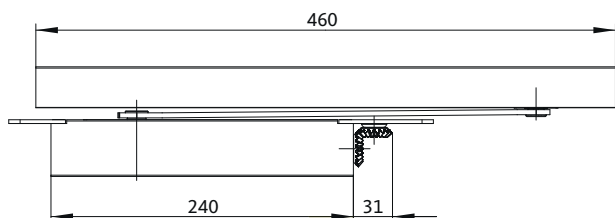
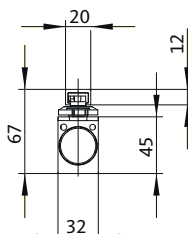

VTS 735 concealed door closer – with functional slide rail
(for SRI door leaf coordinator and FE electromechanical hold-open device)

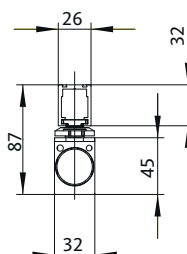

Product features

Door closer

- Tested in accordance with EN 1154
- **EN 3–5 for door leaf widths up to 1250 mm**
- With heart curve technology, thus in compliance with DIN SPEC 1104 and suitable for barrier-free construction according to DIN 18040
- Smallest dimensions (L x H x D): 240 x 45 x 32 mm
- Valve functions
 - Closing speed
 - Latch action
 - Backcheck
- For door leaf thicknesses of 40 mm or more
- Easy and safe closing force adjustment with just a few turns of the adjustment screw (max. 9 turns EN min. up to EN max.)

GS VTS 73x 20x12 standard slide rail

- Dimensions (L x H x D): 440 x 20 x 12 mm
- Retrofittable and can be integrated in the slide rail as an option
 - FM-VTS 73x20x12 mechanical hold-open device^[1]
 - VTS 73x 20x12 ÖB opening restrictor

GS VTS 73x26x32 functional slide rail

- Dimensions (L x H x D): 460 x 26 x 32 mm
- Retrofittable and can be integrated in the slide rail as an option
 - FM-VTS 73x26x32 mechanical hold-open device^[1]
 - FE-VTS 73x26x32 electromechanical hold-open device
 - SRI-VTS 73x26x32 door leaf coordinator
 - ÖB-VTS 73x26x32 opening restrictor

Application ranges

- Fire and smoke protection doors
- For swing doors up to 1250 mm (1-leaf) or 2500 mm (2-leaf)
- DIN left and DIN right
- Max. door opening and closing angle 120°^[2]
- Suitable for all rebate clearance heights up to max. 22 mm
- Min. door leaf width: 600 mm

[1] Not approved for fire and smoke protection doors.

[2] Depending on installation situation. Use door stop for max. door opening angle.



Mechanical hold-open device (FM-VTS 73x 20x12)^[1]

- Can be integrated in the standard slide rail (20 x 12 mm)
- With integrated opening restriction
- Hold-open angle steplessly adjustable from approx. 80°
- Retrofittable



Mechanical hold-open device (FM-VTS 73x 26x32)^[1]

- Can be integrated in the functional slide rail (26 x 32 mm)
- With integrated opening restriction
- Hold-open angle steplessly adjustable from approx. 80°
- Retrofittable



Electromechanical hold-open device (FE-VTS 73x 26x32)

- Can be integrated in the functional slide rail (26 x 32 mm)
- Complete opening beyond hold-open angle possible
- Hold-open angle steplessly adjustable from 80°–120°^[2]
- Steplessly adjustable tripping force
- Retrofittable

[1] Not approved for fire and smoke protection doors. | [2] Depending on installation situation. Use door stop for max. door opening angle.

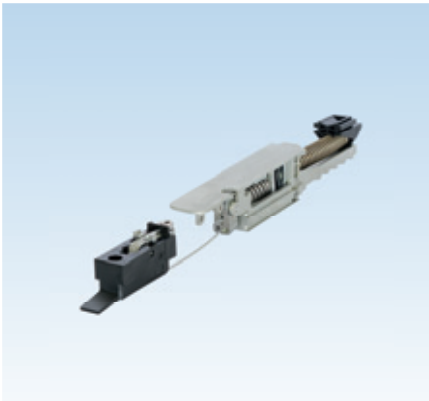

Door-leaf coordinator (SRI-VTS 73x 26x32)

- Can be integrated in the functional slide rail (26 x 32 mm)
- SRI waiting position with load-limiting device prevents damages in case of mishandling
- Optional: with integrated microswitch for conjunction with the FE-VTS electro-mechanical hold-open device. If the active leaf is manually operated, the passive leaf is also automatically closed



Opening restrictor (ÖB-VTS 73x 20x12)

- Can be integrated in the standard slide rail (20 x 12 mm)
- Steplessly adjustable limit angle up to 120°
- Retrofittable



Opening restrictor (ÖB-VTS 73x 26x32)

- Can be integrated in the functional slide rail (26 x 32 mm)
- Steplessly adjustable limit angle up to 120°
- Retrofittable

All solutions at a glance



Door closers

Product name of the closer body variant	OTS 735	OTS 735 BG	OTS 736	OTS 736 BG
Dimensions (with cover) L x H x D in mm	268 x 63 x 44	268 x 63 x 44	268 x 63 x 44	268 x 63 x 44
Closing force sizes according to EN 1154	2-5	2-5	3-6	3-6
Application range				
1-leaf	■	■	■	■
2-leaf	■	■	■	■
Standard installation on hinge-side	■	-	■	-
Transom installation on side opposite to hinges	■	-	■	-
Standard installation on side opposite to hinges	-	■	-	■
Transom installation on hinge-side	-	■	-	■
Approval for fire and smoke protection doors				
Max. leaf width (mm) 1-leaf	1250	1250	1400	1400
Max. leaf width (mm) 2-leaf	2500	2500	2800	2800
Adjustment functions				
Closing speed	■	■	■	■
Latch action / Latching speed	■	■	■	■
Backcheck	■ ^[1]	■	■ ^[1]	■
Delayed action	-	-	-	-
Installation / Functions				
Steplessly adjustable closing force	■	■	■	■
Freewheel function 0°-140°	-	-	-	-
Max. door opening and closing angle (hinge-side / side opposite to hinges) ^[3]	180° / 120°	180° / 120°	180° / 120°	180° / 120°
Opening restrictor ^[2]	Optional	Optional	Optional	Optional
DIN left/right	■	■	■	■
Hold-open device (optional)				
FM mechanical hold-open device FM ^[4] Adjustable hold-open angle	Steplessly 80°-140° (opening beyond hold-open angle possible)	Steplessly 80°-120° (opening beyond hold-open angle possible) ^[3]	Steplessly 80°-140° (opening beyond hold-open angle possible)	Steplessly 80°-120° (opening beyond hold-open angle possible) ^[3]
FE electromechanical hold-open device Adjustable hold-open angle	Steplessly 85°-140° (opening beyond hold-open angle possible)	Steplessly 85°-120° (opening beyond hold-open angle possible) ^[3]	Steplessly 85°-140° (opening beyond hold-open angle possible)	Steplessly 85°-120° (opening beyond hold-open angle possible) ^[3]

[1] Not effective for transom installation on side opposite to hinges
[2] No substitute for doorstop

[3] Depends on the installation situation, BS = hinge-side / BG = side opposite to hinges
[4] Not approved for fire and smoke protection doors

OTS 736 SV	OTS 736 SV BG	OTS 735 FL	OTS 735 FL BG	OTS 736 FL	OTS 736 FL BG	VTS 735 VTS 735/4
268 x 63 x 44	268 x 63 x 44	319 x 65.5 x 45	319 x 65.5 x 45	319 x 65.5 x 45	319 x 65.5 x 45	240 x 45 x 32
3-6	3-6	5	5	6	6	3-5
■	■	■	■	■	■	■
■	■	■	■	■	■	■
■	-	■	-	■	-	-
■	-	■	-	■	-	-
-	■	-	■	-	■	-
-	■	-	■	-	■	-
-	-					
1400	1400	1250	1250	1400	1400	1250
2800	2800	2500	2500	2800	2800	2500
■	■	■	■	■	■	■
■	■	■	■	■	■	■
■ ^[3]	■	-	-	-	-	■
■	■	-	-	-	-	-
-	-	-	-	-	-	■
-	-	■	■	■	■	-
180° / 120°	180° / 120°	180° / 120°	180° / 120°	180° / 120°	180° / 120°	120°
Optional	Optional	Optional	Optional	Optional	Optional	Optional
■	■	■	■	■	■	■
Steplessly 80°-140° (opening beyond hold-open angle possible)	Steplessly 80°-120° (opening beyond hold-open angle possible) ^[3]	-	-	-	-	Steplessly from 80°
Steplessly 85°-140° (opening beyond hold-open angle possible)	Steplessly 85°-120° (opening beyond hold-open angle possible) ^[3]	-	-	-	-	Steplessly from 80°

Hold-open systems in accordance with EN 1155

officially approved by DIBt (German Institute of Building Engineering)



High level of safety with low-key presence

Their capability goes unnoticed during everyday use, but is indispensable when serious situations arise: electrical hold-open systems are part of preventative fire protection. They perform the task of keeping fire barriers in escape and rescue routes open, especially fire and smoke protection doors. They do this so efficiently that many people pass through the door during everyday operations without noticing it. When fire breaks out on the other hand, an integrated smoke detector triggers the system and the door closes automatically. Thus preventing the spread of smoke gases and fire to adjacent rooms and buildings as legally-prescribed.

Application areas

Fire barriers in escape and rescue routes, fire and smoke protection doors, for example.

These doors are normally used in kindergartens, hospitals, schools, hotels and residential homes for the elderly. In addition to fire protection, their purpose is to provide barrier-free access to children, elderly persons and persons with disabilities.

As a whole they therefore ensure a smooth flow of public and goods traffic during daily operations.

Test requirements/Approval

In Germany, technical approval is required for hold-open systems and is issued by the German Institute of Building Engineering (DIBt). This fundamentally requires that only complete systems, consisting of tested and certified individual components can be approved. If non-approved components are subsequently installed, the testing must be carried out again.



Fig. above:
Hold-open system during daily operations



Fig. on right:
Hold-open system in the event of fire

System structure

A hold-open system consists of the following components:

- at least one fire detection element for smoke and heat detection, the ORS 142 **1** or ORS 142 W **2** optical smoke switch
- one power supply unit for energy supply, the NAG 03 power supply and tripping unit, for example **3**
- a tripping unit to initiate the closing operation, the NAG 03 power supply and tripping unit, for example **3**
- a hold-open device that holds the door open, for example
 - an electromechanical hold-open device integrated into the slide rail (FE-OTS 73x or FE-VTS 735) **4** or
 - an integrated hold-open system (OTS 73x FL or VTS 735 FL) **4** or
 - a hold-open magnet (electromagnetic) **5**
- an on-wall/in-wall manual release push-button as switch **6**



RSM smoke switch module

- For supplying electricity to all components of a hold-open system (hold-open device, electromechanical hold-open magnet, fire detector, smoke release push-button and other elements)
- Tested and approved by DIBt (German Institute of Building Engineering)
- With integrated power supply and release mechanism
- With integrated smoke switch
- With LED status indication
 - Operation/Alarm
 - Interference
 - Soiling
- Cover in GU design, in the same look as the AD-OTS 73x cover
- Installation height: 36 mm



NAG 03 power supply unit

- For the voltage supply of smoke switch systems
- Officially approved by DIBt (German Institute of Building Engineering)
- Highly efficient switched-mode power supply
- Terminal clamps for all external devices



Manual release push-buttons

- For the manual release of hold-open devices (door holding magnets, electromechanical hold-open devices) in accordance with the directives of the German Institute of Building Engineering (DIBt)
- For surface and flush mounting
- Technical data
 - Contact type: opener
 - Switching voltage: 30 V DC
 - Switching current: 1 A
 - Protection type: IP44



ORS 142 optical smoke switch

- Suited for the early recognition of smoldering fire and naked flames with smoke emission
- Smoke detection according to EN 54, part 7
- Officially approved by DIBt (German Institute of Building Engineering)
- For ceiling and wall mounting
- With alarm threshold tracking and contamination indicator
- Sensing chamber monitoring



ORS 142 W optical smoke switch

- Suited for the early recognition of smoldering fire and naked flames with smoke emission
- Smoke detection according to EN 54, part 7
- Officially approved by DIBt (German Institute of Building Engineering)
- As lintel-mounted smoke detector for wall mounting
- With alarm threshold tracking and contamination indicator



Hold-open magnets

Different versions

- For on-wall mounting
- For wall and floor mounting
- With/without swivel head
- With/without switch
- Holding force 490 N

Successfully certified



OTS 73x surface-mounted overhead door closers



EN 1154 OTS 73x



EN 1155 FE-OTS 73x



EN 1158 SRI-OTS 73x



EN 1155 OTS 73x FL

VTS 73x concealed door closers



EN 1154 VTS 73x



EN 1155 FE-VTS 73x



EN 1158 SRI-VTS 73x

Hold-open systems



OTS 73x/VTS 73x

Systematic Service

A product on its own is not a solution. The right security, function and cost-effectiveness can only be achieved with the right planning and by ensuring correct application. The GU Group therefore also applies the systematic thought processes demonstrated in its product range to its service offering. Close interlinking of one-to-one expert advice, free online support and a comprehensive programme of technical seminars aims to make the day-to-day work of customers easier.

All aspects covered: from hotline for architects to technical drawings



Service and maintenance

Competent, individual and on location: when it comes to security areas, fire protection and barrier freedom, the GU Group offers comprehensive support in all project phases. Trained experts with a wide range of knowledge of all relevant standards and regulations provide support for the project from the design planning phase, to mounting and installation, all the way through to regular system maintenance.



Building project consulting

Simplifies everyday work: building project consulting assists architects and planners with project-specific drawings and door schedules, cable diagrams and tender specifications or conceptual designs with functional descriptions, for example. Well thought-out and coordinated system solutions guarantee functionality and compliance with the required standards and directives.

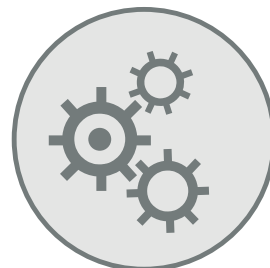

Door engineering

Step by step to the right door solution: with its Door Engineering concept, the GU Group developed an efficient method for configuring individual doors. Cross-trade solutions are prepared based on experimental models. The documentation ensures maximum planning reliability based on clearly laid-out door configuration lists.



Hotline for architects

For all those with planning questions or who require detailed information on the products of the GU Group: the building project consultants at the hotline for architects (service only available in Germany) provide personal expert advice: by telephone 02051/201-2000, email objektberatung@g-u.de or can also be contacted using the form at the company website www.g-u.com.

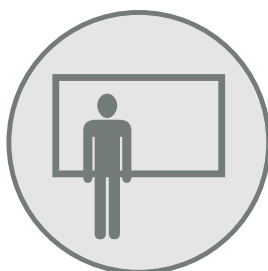

Seminars and training courses

Practical knowledge based on first hand experience: with around 160 events annually GU Group offers an extremely wide range of seminars and training courses. The programme includes product innovations and their applications, current architectural trends, standards and directives. Several seminars and training courses are certified and recognised as advanced training courses by the chamber of architects and civil engineers in Germany.

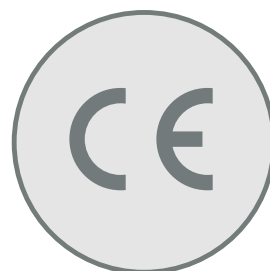

CE-certified products

Safety in black and white: all overhead door closers in the OTS 73x series are CE-certified. This is how the GU Group gives their customers confirmation that the products meet the requirements of the European Union. In addition, by using CE marking, the GU Group takes responsibility for the fact that the products fulfil all the characteristics defined in the Declaration of Performance.



Tender-Text-Manager

Comprehensive, legally sound and technically up-to-date: with the Tender-Text-Manager, GU Group is offering architects and planners a convenient and effective online tool that allows them to effortlessly compile technical specifications and complete tender specifications – for all GU Group products.

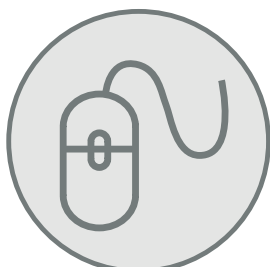

Customer Information System

Available at the click of a mouse: the Customer Information System (CIS) is an ordering and information system for all GU Group products. Customers can use the online platform 24 hours a day 7 days a week to access important information: from preparing a quotation through to performing an availability check in real time, from placing the order to order tracking.



confiGUrator

The right products in the right quantity: the practical confiGUrator is an online platform where part lists and hardware sets can be precisely determined. Based on the specifications for the particular project, a technically correct part list is generated within seconds. The data is determined based on current conditions and fundamental technical principles.

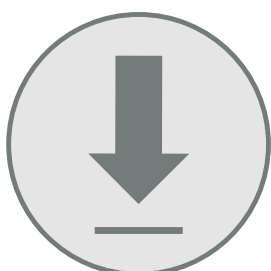

Free download

To make planning easier: a wide range of information on the products and applications is available to download from the company website to the local hard drive quickly, conveniently and free of charge: from product documents and installation drawings to Declarations of Performance through to software solutions.



Provision of samples

Impressive not just for builders: quality and functionality are best experienced live on site. The GU Group therefore organises the provision of samples for the project from start to finish and can also present different variants and functions if required. As an alternative, the GU Group offers visits to reference projects worldwide.



Quality in black and white

You can rely on this: virtually all variants of the GU Group's range of door closers are tested and certified to meet the relevant EN 1154, EN 1155 and EN 1158 standards. And all GU Group hold-open systems are approved by DIBt (German Institute of Building Engineering).



WINDOW TECHNOLOGY
DOOR TECHNOLOGY
AUTOMATIC ENTRANCE SYSTEMS
BUILDING MANAGEMENT SYSTEMS

Gretsch-Unitas GmbH
Baubeschläge
Johann-Maus-Str. 3
D-71254 Ditzingen
Tel. + 49 7156 301-0
Fax + 49 7156 301-77980

BKS GmbH
Heidestr. 71
D-42549 Velbert
Tel. + 49 2051 201-0
Fax + 49 2051 201-9733

www.g-u.com

Securing technology for you



Door closers with slide rail – the modular system of OTS 73x series

Hinge-side



Modular components

 1A AD-OTS 73x cover Order no. K-18338-00-0-*	 1B OTS 73x closer body OTS 735 – Order no. K-18343-00-0-1 OTS 736 – Order no. K-18345-00-0-1	 2 GS slide rail (with slide arm) Order no. K-18351-00-0-*	 3 AD-GS slide rail cover Order no. K-18364-00-0-*	 4 FM mechanical hold-open device with ÖB*** Order no. K-18369-00-0-6	 5 FE electromechanical hold-open device Order no. K-18368-00-0-6
 6 AD-GS-FE cover for electromechanical hold-open device Order no. K-18365-00-0-*	 7BS SRI door leaf coordinator Order no. K-18834-00-0-1	 8 AD-SRI cover for door leaf coordinator Order no. K-18367-00-0-*	 9 RSM smoke switch module Order no. K-19058-00-0-*	 10 MP mounting plate** Order no. K-18280-00-0-1	 11 ÖB opening restrictor Order no. K-18916-00-0-6

Sets for 1-leaf solutions

<p>Door closer with GS slide rail</p>  <ul style="list-style-type: none"> 1B OTS 73x closer body 1A AD-OTS 73x 2 GS 	<ul style="list-style-type: none"> ■ OTS 735 set with GS K-18360-00-0-* ■ OTS 736 set with GS K-18362-00-0-* <p>Option:</p> <ul style="list-style-type: none"> ■ 3 AD-GS K-18364-00-0-* ■ 4 FM K-18369-00-0-6 ■ 11 ÖB**** K-18916-00-0-6 ■ 10 MP K-18280-00-0-1 		<p>F Suitability for fire protection</p> <p>Complete modular system tested in accordance with</p> <ul style="list-style-type: none"> EN 1154 (door closer) EN 1158 (door leaf coordinator) EN 1155 (FE electromechanical hold-open device) <p>and approved for use on fire and smoke protection doors</p> <p>The closer type has to be selected depending on the required closing force size</p> <p>OTS 735 = EN 2-5 (door leaf width up to 1250 mm) OTS 736 = EN 3-6 (door leaf width up to 1400 mm)</p> <p>Abbreviations</p> <table border="0"> <tr><td>AD-OTS 73x</td><td>Door closer body</td></tr> <tr><td>AD-GS</td><td>Slide rail cover</td></tr> <tr><td>AD-GS-FE</td><td>Cover for electromechanical hold-open device</td></tr> <tr><td>AD-SRI</td><td>Cover for door leaf coordinator</td></tr> <tr><td>BG</td><td>Side opposite to hinges</td></tr> <tr><td>BS</td><td>Hinge-side</td></tr> <tr><td>FE</td><td>Electromechanical hold-open device</td></tr> <tr><td>FM</td><td>Mechanical hold-open device</td></tr> <tr><td>GS</td><td>Slide rail</td></tr> <tr><td>MP</td><td>Mounting plate</td></tr> <tr><td>ÖB</td><td>Opening restrictor</td></tr> <tr><td>OTS</td><td>Overhead door closer</td></tr> <tr><td>RSM</td><td>Smoke switch module</td></tr> <tr><td>SRI</td><td>Door leaf coordinator, integrated</td></tr> </table>	AD-OTS 73x	Door closer body	AD-GS	Slide rail cover	AD-GS-FE	Cover for electromechanical hold-open device	AD-SRI	Cover for door leaf coordinator	BG	Side opposite to hinges	BS	Hinge-side	FE	Electromechanical hold-open device	FM	Mechanical hold-open device	GS	Slide rail	MP	Mounting plate	ÖB	Opening restrictor	OTS	Overhead door closer	RSM	Smoke switch module	SRI	Door leaf coordinator, integrated
AD-OTS 73x	Door closer body																														
AD-GS	Slide rail cover																														
AD-GS-FE	Cover for electromechanical hold-open device																														
AD-SRI	Cover for door leaf coordinator																														
BG	Side opposite to hinges																														
BS	Hinge-side																														
FE	Electromechanical hold-open device																														
FM	Mechanical hold-open device																														
GS	Slide rail																														
MP	Mounting plate																														
ÖB	Opening restrictor																														
OTS	Overhead door closer																														
RSM	Smoke switch module																														
SRI	Door leaf coordinator, integrated																														
<p>Door closer without GS slide rail</p>  <ul style="list-style-type: none"> 1B OTS 73x closer body 1A AD-OTS 73x 	<ul style="list-style-type: none"> ■ OTS 735 set without GS K-18498-00-0-* ■ OTS 736 set without GS K-18500-00-0-* <p>Option:</p> <ul style="list-style-type: none"> ■ 10 MP K-18280-00-0-1 																														
<p>GS FE-OTS 73x slide rail</p>  <ul style="list-style-type: none"> 5 FE 2 GS 6 AD-GS-FE 	<ul style="list-style-type: none"> ■ GS FE-OTS 73x set K-18352-00-0-* 																														
<p>GS FER-OTS 73x slide rail</p>  <ul style="list-style-type: none"> 5 FE 2 GS 6 AD-GS-FE 9 RSM 	<ul style="list-style-type: none"> ■ GS FER-OTS 73x set K-18353-00-0-* 																														

Sets for 2-leaf solutions

<p>Door closer without GS slide rail</p>  <ul style="list-style-type: none"> 1B OTS 73x closer body 1A AD-OTS 73x 	<ul style="list-style-type: none"> ■ OTS 735 set without GS 2x K-18498-00-0-* ■ OTS 736 set without GS 2x K-18500-00-0-* <p>Option:</p> <ul style="list-style-type: none"> ■ 2x 10 MP 2x K-18280-00-0-1 	
<p>GS SRI-OTS 73x slide rail</p>  <ul style="list-style-type: none"> 2 2x GS 3 2x AD-GS 7BS SRI 8 AD-SRI 	<ul style="list-style-type: none"> ■ GS SRI-OTS 73x set K-18354-00-0-* <p>Option:</p> <ul style="list-style-type: none"> ■ 2x 4 FM 2x K-18369-00-0-6 ■ 2x 11 ÖB**** 2x K-18916-00-0-6 	
<p>GS FE-SRI-OTS 73x slide rail</p>  <ul style="list-style-type: none"> 2 2x GS 5 2x FE 6 2x AD-GS-FE 7BS SRI 8 AD-SRI 	<ul style="list-style-type: none"> ■ GS FE-SRI-OTS 73x set K-18355-00-0-* 	
<p>GS FER-SRI-OTS 73x slide rail</p>  <ul style="list-style-type: none"> 2 2x GS 5 2x FE 6 2x AD-GS-FE 7BS SRI 8 AD-SRI 9 RSM 	<ul style="list-style-type: none"> ■ GS FER-SRI-OTS 73x set K-18356-00-0-* 	

* Colour: silver (-1), black (-6), white RAL 9016 (-7), stainless steel (-8), special colour (-9)
** Mounting plates are required for use on fire and smoke protection doors
*** Not approved for fire and smoke protection doors
**** Not required if a FM mechanical hold-open device exists

Components shown in grey are optional and have to be ordered separately
With 2-leaf doors it may be necessary to use a carrier bar

Door closers with slide rail – the modular system of OTS 73x series



Side opposite to hinges



Modular components

					
1A AD-OTS 73x cover Order no. K-18338-00-0-*	1B OTS 73x BG closer body OTS 735 BG – order no. K-18344-00-0-1 OTS 736 BG – order no. K-18346-00-0-1	2 GS slide rail (with slide arm) Order no. K-18351-00-0-*	3 AD-GS slide rail cover Order no. K-18364-00-0-*	4 FM mechanical hold-open device with ÖB*** Order no. K-18369-00-0-6	5 FE electromechanical hold-open device Order no. K-18368-00-0-6
					
6 AD-GS-FE cover for electromechanical hold-open device Order no. K-18365-00-0-*	7BG SRI-BG door leaf coordinator Order no. K-18835-00-0-1	8 AD-SRI cover for door leaf coordinator Order no. K-18367-00-0-*	9 RSM smoke switch module Order no. K-19058-00-0-*	10 MP mounting plate** Order no. K-18280-00-0-1	11 ÖB opening restrictor Order no. K-18916-00-0-6

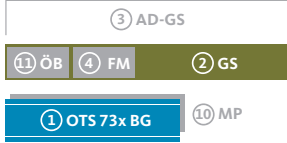
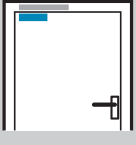
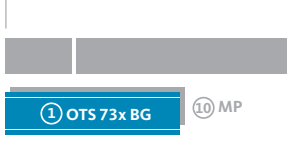
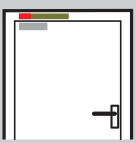
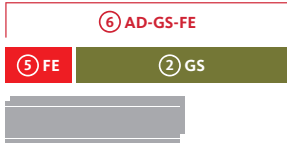
Sets for 1-leaf solutions

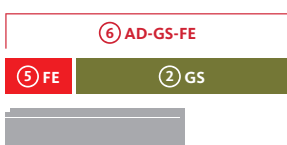
<p>BG door closer with GS slide rail</p>  <ul style="list-style-type: none"> 1B OTS 73x BG closer body 1A AD-OTS 73x 2 GS 	<ul style="list-style-type: none"> ■ OTS 735 BG set with GS K-18361-00-0-* ■ OTS 736 BG set with GS K-18363-00-0-* <p>Option:</p> <ul style="list-style-type: none"> ■ 3 AD-GS K-18364-00-0-* ■ 4 FM K-18369-00-0-6 ■ 11 ÖB**** K-18916-00-0-6 ■ 10 MP K-18280-00-0-1 	
<p>BG door closer without GS slide rail</p>  <ul style="list-style-type: none"> 1B OTS 73x BG closer body 1A AD-OTS 73x 	<ul style="list-style-type: none"> ■ OTS 735 BG set without GS K-18499-00-0-* ■ OTS 736 BG set without GS K-18501-00-0-* <p>Option:</p> <ul style="list-style-type: none"> ■ 10 MP K-18280-00-0-1 	
<p>GS FE-OTS 73x slide rail</p>  <ul style="list-style-type: none"> 5 FE 2 GS 6 AD-GS-FE 	<ul style="list-style-type: none"> ■ GS FE-OTS 73x set K-18352-00-0-* 	
<p>GS FER-OTS 73x slide rail</p>  <ul style="list-style-type: none"> 5 FE 2 GS 6 AD-GS-FE 9 RSM 	<ul style="list-style-type: none"> ■ GS FER-OTS 73x set K-18353-00-0-* 	

F Suitability for fire protection

Complete modular system tested in accordance with

- EN 1154 (door closer)
- EN 1158 (door leaf coordinator)
- EN 1155 (FE electromechanical hold-open device)

and approved for use on fire and smoke protection doors







The closer type has to be selected depending on the required closing force size

OTS 735 BG = EN 2–5 (door leaf width up to 1250 mm)
OTS 736 BG = EN 3–6 (door leaf width up to 1400 mm)

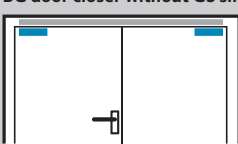
Abbreviations

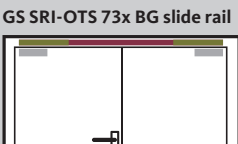
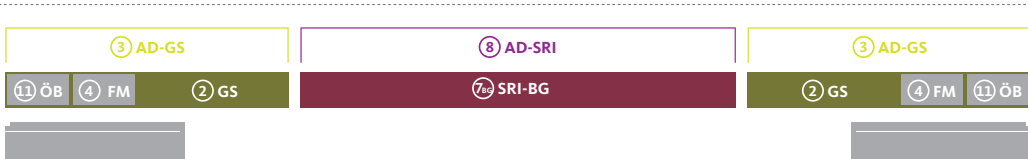
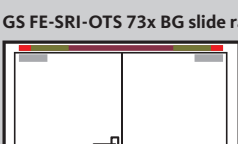
AD-OTS 73x	Door closer body
AD-GS	Slide rail cover
AD-GS-FE	Cover for electromechanical hold-open device
AD-SRI	Cover for door leaf coordinator
BG	Side opposite to hinges
BS	Hinge-side
FE	Electromechanical hold-open device
FM	Mechanical hold-open device
GS	Slide rail
MP	Mounting plate
ÖB	Opening restrictor
OTS	Overhead door closer
RSM	Smoke switch module
SRI-BG	Door leaf coordinator, integrated – side opposite to hinges

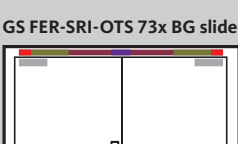
Sets for 2-leaf solutions

<p>BG door closer without GS slide rail</p>  <ul style="list-style-type: none"> 1B OTS 73x BG closer body 1A AD-OTS 73x 	<ul style="list-style-type: none"> ■ OTS 735 BG set without GS 2x K-18499-00-0-* ■ OTS 736 BG set without GS 2x K-18501-00-0-* <p>Option:</p> <ul style="list-style-type: none"> ■ 2x 10 MP 2x K-18280-00-0-1 	
<p>GS SRI-OTS 73x BG slide rail</p>  <ul style="list-style-type: none"> 2 2x GS 3 2x AD-GS 7BG SRI-BG 8 AD-SRI 	<ul style="list-style-type: none"> ■ GS SRI-OTS 73x BG set K-18357-00-0-* <p>Option:</p> <ul style="list-style-type: none"> ■ 2x 4 FM 2x K-18369-00-0-6 ■ 2x 11 ÖB**** 2x K-18916-00-0-6 	
<p>GS FE-SRI-OTS 73x BG slide rail</p>  <ul style="list-style-type: none"> 2 2x GS 5 2x FE 6 2x AD-GS-FE 7BG SRI-BG 8 AD-SRI 	<ul style="list-style-type: none"> ■ GS FE-SRI-OTS 73x BG set K-18358-00-0-* 	
<p>GS FER-SRI-OTS 73x BG slide rail</p>  <ul style="list-style-type: none"> 2 2x GS 5 2x FE 6 2x AD-GS-FE 7BG SRI-BG 8 AD-SRI 9 RSM 	<ul style="list-style-type: none"> ■ GS FER-SRI-OTS 73x BG set K-18359-00-0-* 	

* Colour: silver (-1), black (-6), white RAL 9016 (-7), stainless steel (-8), special colour (-9)
** Mounting plates are required for use on fire and smoke protection doors
*** Not approved for fire and smoke protection doors
**** Not required if a FM mechanical hold-open device exists

Components shown in grey are optional and have to be ordered separately
With 2-leaf doors it may be necessary to use a carrier bar